

COMPOSTING

*A Disposal Method
for Fish Waste*

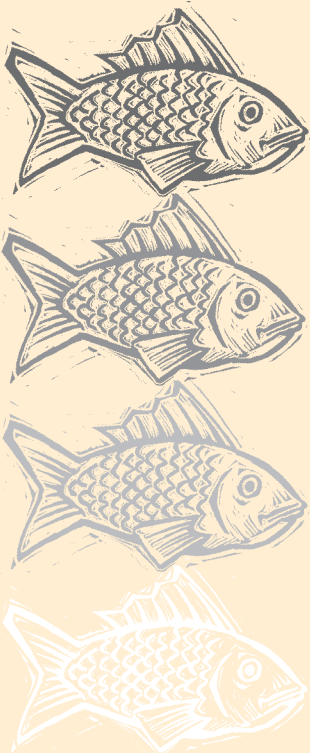

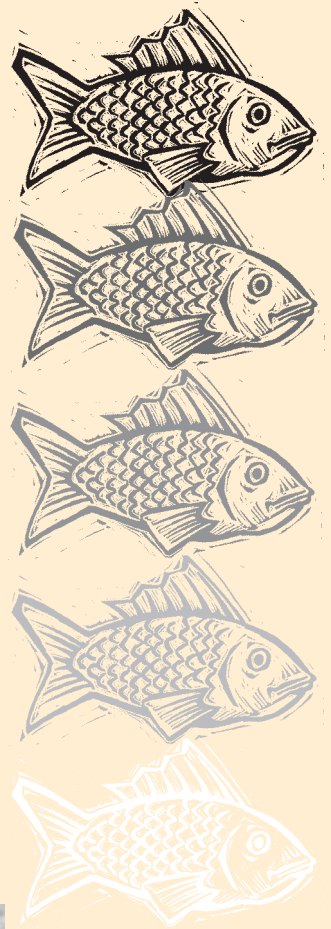

LSU Ag Center Experiment Dispels Fish Smell

Dr. Tom Lawson, a biological engineer with the LSU Agricultural Center (retired), standing, has designed a fish composting station, which is relatively easy to construct, as a way to get rid of unwanted fish parts and their offensive odor. Research associate David Schellinger is helping him construct this one at Grand Isle, La. The secret to dispelling the smell is to layer the unwanted fish parts with rice hulls, a product left over from rice milling that can be acquired for about \$5 a ton. The cost of materials for the station is about \$300.



Composting -- A Disposal Method for Fish Waste

Composting fish waste is a relatively new, practical and an environmentally sound alternative to disposing of fish waste. It is economical, fairly odorless and a biologically beneficial practice for seafood operations. **A commitment to proper management of the compost bins is the key to successful composting.**

Composting resolves the disposal problem and produces a valuable product, a humus-like material that has several marketable uses from soil conditioner to horticultural growing medium. Composting has many values:



Composting is environmentally sound. Properly done, it decreases the potential for surface and groundwater contamination.



Composting destroys disease-causing organisms and fly larvae.



The materials needed for composting (fish waste, rice hulls, wood chips, straw and water) are usually readily available.



Once a composting system has been set up, it will not require much labor.



Compared to other disposal options, composting is not a costly method of fish waste disposal.

A Natural Process

Composting is a controlled, natural, aerobic (uses air) process in which heat, bacteria and fungi, along with carbon (rice hulls, wood chips and straw), nitrogen (fish waste), oxygen (air) and moisture, decompose the fish waste, changing it into a stable product—compost.

The fisherman's tasks are to collect the fish waste and place it in several layers with the rice hulls, wood chips and straw (or other carbon sources) and to manage the process to ensure that the process of composting is complete. The fisherman will have to turn the composting mixture, usually by moving it from one bin into another. Turning assures that the compost gets enough oxygen (air) to complete the process.

Composter Bin Design and Operation

How do I contain the pile? In commercial or municipal composting facilities, materials are usually placed on the ground in long narrow piles, called windrows. In some facilities, composting is done on large concrete pads. The piles can be mechanically aerated or turned with windrow turners. Where smaller amounts of materials are composted, it is often more practical to contain the material in a bin or some other type of enclosure rather than to stack it in a loose heap. Many types of compost bins are available, ranging from small plastic backyard bins holding about 9 cubic feet of material to larger mechanically rotated bins holding several cubic yards of material.



For composting wastes from marina fish cleaning stations, we recommend enclosed static compost bins. These can be constructed from woven wire fencing, discarded wooden pallets, cement blocks or scrap lumber. Two examples of static pile compost bins are shown in Figure 1.

Figure 1 - Wire mesh and wooden box bin

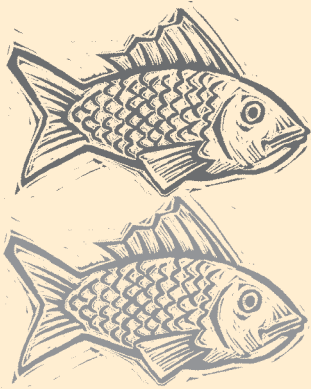
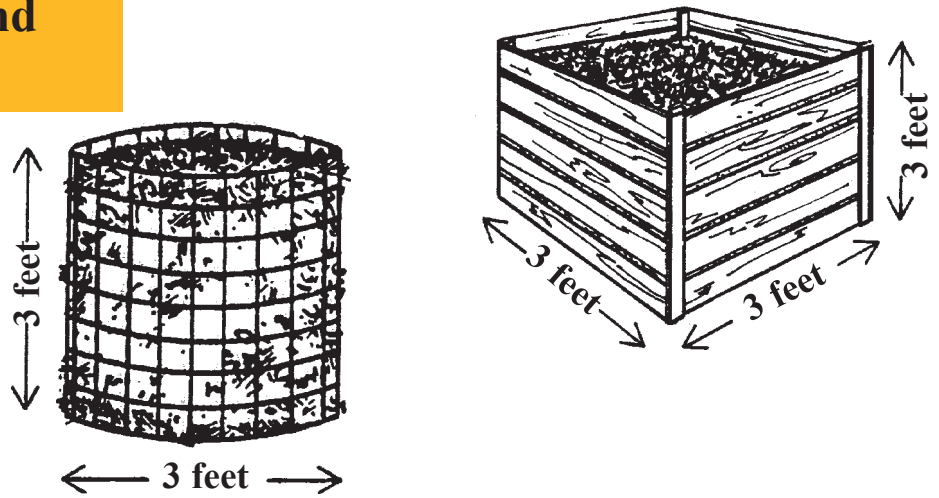

A three-bin compost system suitable for disposal of fish cleaning wastes is illustrated in Figures 2 and 3. This system was used successfully in compost research at the LSU Agricultural Center. It is attractive and inexpensive, costing less than \$300 to construct. Each bin holds about 85 cubic feet of compost.

**Figure 2 -
A three-bin compost system**

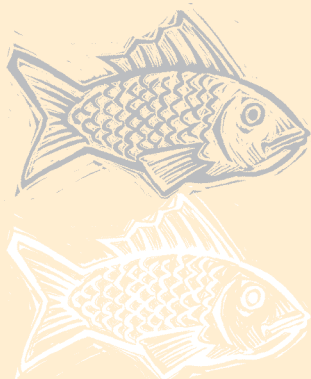
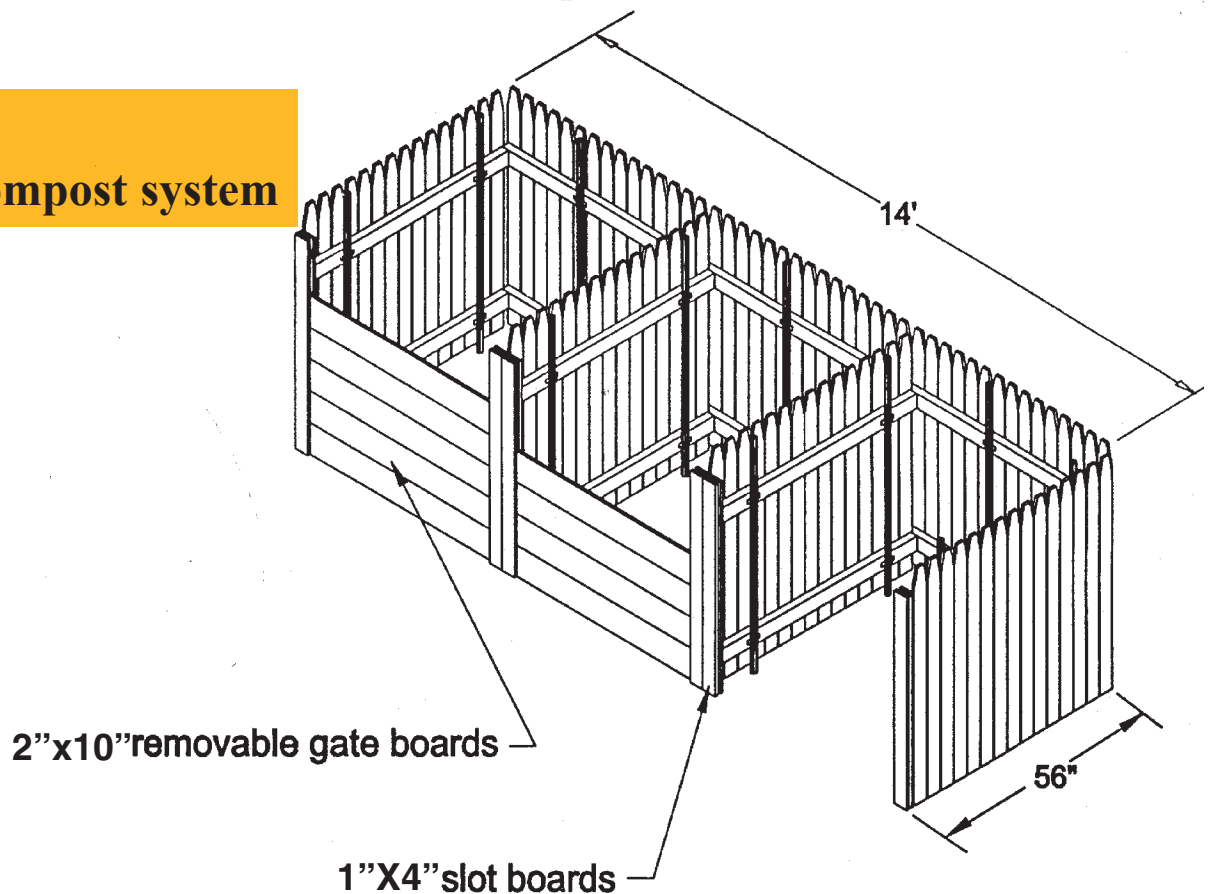
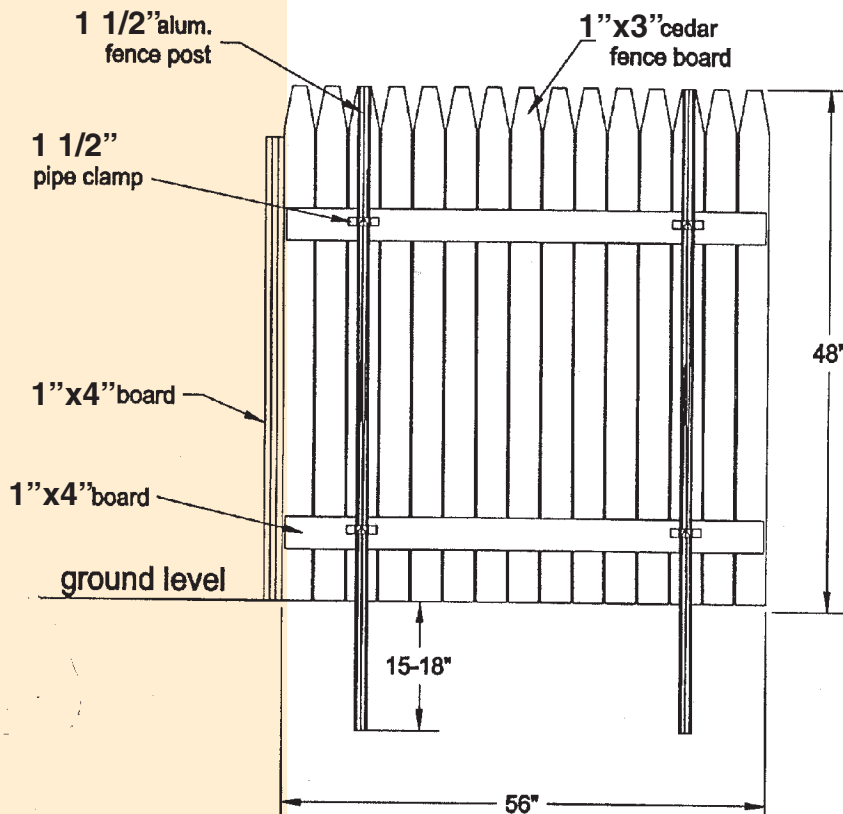

Figure 3 - Detail of compost bin panels



A three-bin system is managed as follows: After the first bin is full, begin filling the second bin. By the time the second bin is full, the first bin can be turned by shoveling it over into the third bin. Each pile can be alternately turned in this manner every several days, until compost is complete.

Systems can be made smaller or larger than shown, but it is not recommended that an individual bin be smaller than 3 feet x 3 feet x 3 feet. Smaller piles remain cooler and don't allow the proper internal temperatures to be reached during composting. This results in incomplete decomposition.

Where do I place the bins? The compost bins should be placed in a convenient, but out-of-the-way, location.

The compost can be placed either on bare ground, concrete slabs or on a base of shell or gravel. Don't place the bins close to trees because the roots may spread and grow into the compost. If possible, locate the compost near a source of water so it can be moistened during periods of drought. If wet weather is experienced for long periods, it may be necessary to cover the compost so it doesn't become too wet.

Don't place compost bins too near waterways. If much leachate is produced, this material may leach through the ground into the waterway or wash into the waterway during rainfall. Large amounts of leachate can cause localized oxygen depletion and fish kills.

Constructing the pile. In situations where bins are to be filled gradually by adding materials daily, layering is recommended. The pile is begun by first putting down an 6- to 12-inch layer of the bulking agent followed by a 6- to 8-inch layer of fish cleaning wastes (see **Figure 4**). Each layer of fish wastes should be followed by a 2- to 3-inch layer of bulking agent until the bin is full. The compost should be "capped" by a thick (8- to 10-inch) layer of bulking agent to prevent odors. When the first bin is full, begin filling the second bin.

Each layer of fish wastes should be no thicker than 6 to 8 inches. If the layer is too thick, the microbes may use up all the oxygen in the layer and anaerobic conditions will develop, along with associated putrid odors. **Raw fish wastes should not be exposed at any point in the pile, or it will attract flies and other animals.**

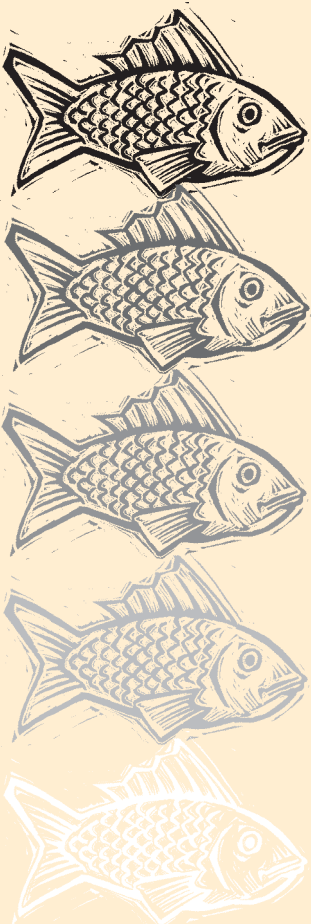
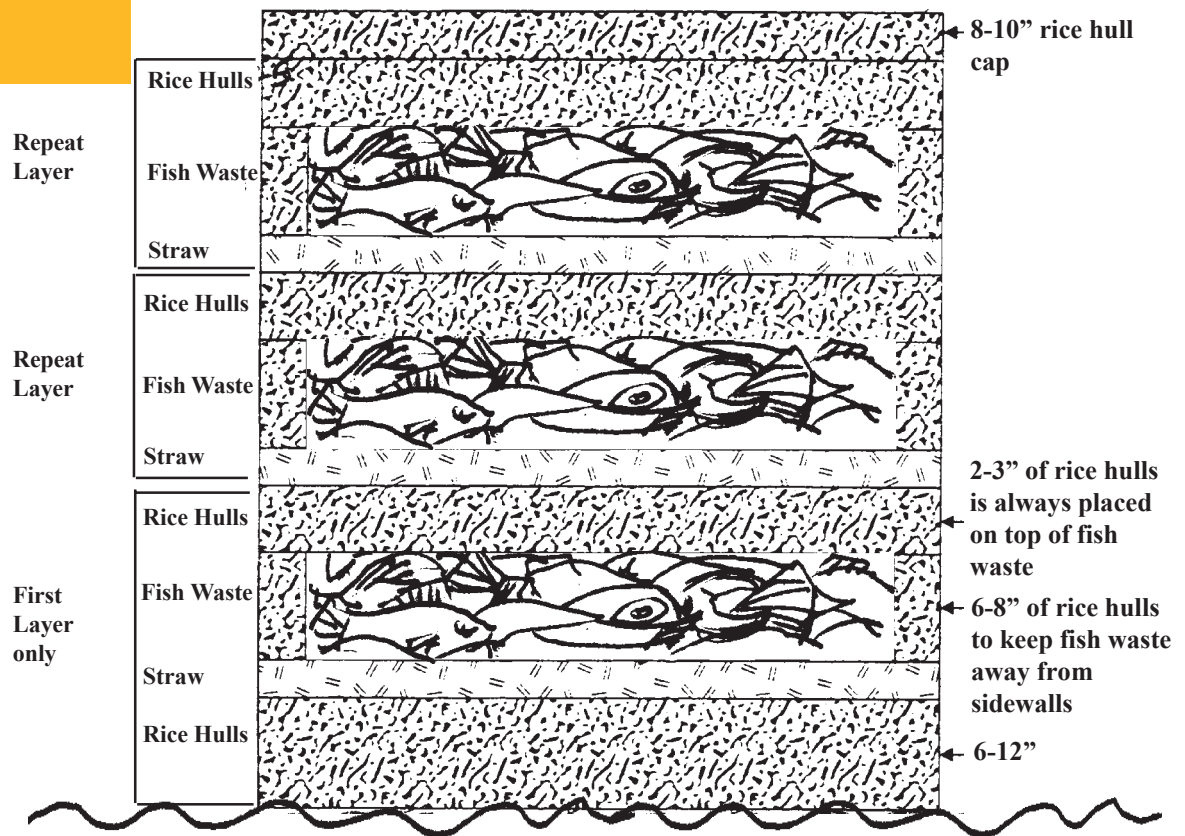

Figure 4

Typical recipe of composting fish waste with rice hulls, straw and water as ingredients.

Ingredients	Parts by Volume
FW	1.0
RH	1.5
Straw	0.5-0.75
Water	0.0-0.5

Water as an ingredient may not be necessary. Too much water can result in anaerobic conditions. An alternate recipe uses 1 part FW with 2 to 3 parts of RH (FW having a high moisture content).



Why do I need to turn the pile and add water? In addition to nutrients, microbes need water and oxygen. After the materials are added to the pile, they are allowed to sit for several weeks or months to decompose and form compost. During the decomposition period, water must be added periodically to keep the pile moist. Water can be added with a garden hose during the long dry periods. Compost should never get soggy, or odors will develop. Also, the pile must be turned every 10 to 14 days to aerate the mass and keep it from becoming odorous. This can be accomplished by hand with a pitchfork or shovel, or it can be done mechanically with a compost turner or front end loader. In large commercial or municipal compost facilities, large tractor-drawn compost turners are used to aerate the piles. Before or during turning is usually the time to add water to the pile.

What do I watch for? The compost process is monitored by observing the daily variation in temperature at the center of the pile. In properly functioning compost, the temperature should rise to 140 to 160 degrees F within a few days. It will then drop rapidly, signaling that the pile should be turned and aerated or water is needed. After turning, the temperature will rise rapidly again and then experience a gradual decline to about ambient temperature, at which time the compost process can be considered nearly complete.

Compost temperature can be monitored by placing a compost thermometer at the center of the pile. Inexpensive thermometers are available at most garden centers for \$10 to \$15.

Watch for flies and the development of odors. This can usually be remedied by adding an extra thick layer of moist rice hulls or wood chips on the top of the pile.

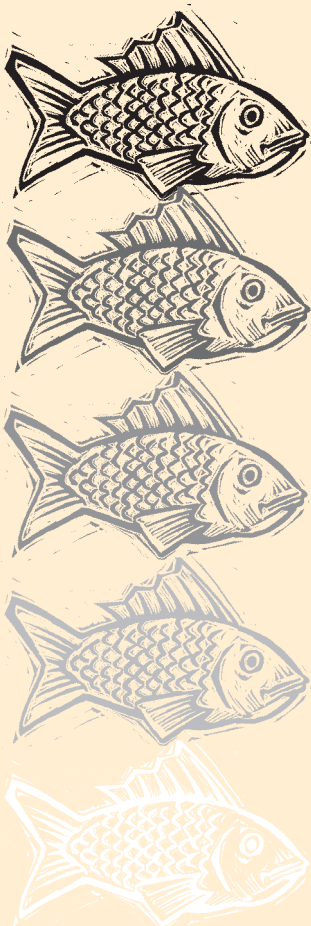

Which bulking agent should I use? Common bulking agents available in south Louisiana are bagasse, cotton gin trash, rice hulls, hay and bark. We recommend **rice hulls** for a number of reasons.

- 1) They are available most of the year and are inexpensive.
- 2) They contain a high percentage of silica, which makes their degradation difficult, thus they can be reused.
- 3) Their granular size and shape help to provide air circulation throughout the compost pile.

How can I use the compost? After the compost is complete, use it in gardens and flower beds to supplement regular fertilization. Compost should never be considered a complete fertilizer, but research shows that it makes a great soil conditioner or mulch, retains moisture and is a good secondary source of nutrients for plants. Complete compost can be spread over land also. Often, local gardeners can be notified when the compost is complete, and they will offer to haul the material themselves, thus saving the compost operator additional work.

Frequently Asked Questions About Fish Waste Composting

Are special ingredients required for composting?

The process described does not use inoculants, chemicals or other commercial additives. These may (or may not) improve the operation of a composter. The simple process and materials discussed will produce the required decomposition of carcasses.

Do composters produce an odor?

Except when moving compost, there should be no objectionable odor from the composter. Movement of compost releases some odor. The odor is not that of decomposing carcasses, and it abates quickly after moving is completed.

Are flies a problem?

Fly breeding has not been a problem with composters. If the composter is operating properly, temperatures higher than 130 degrees F generated throughout the material are sufficient to kill maggots already in carcasses when they are placed into the composter. A 6- to 8-inch covering with bulking material will discourage flies.

Do composters fail, and why?

Occasionally, composters fail to reach an adequate temperature, or they may produce odors and seepage. Composting is a biological process that depends on providing an environment favorable for microbiological decomposition. Common mistakes are failure to provide all the materials needed for food and aeration or sloppy loading of bins so that materials are not "sandwiched."

Too much water is also a common problem. Saturated compost piles are anaerobic (no oxygen) and will not support the desired aerobic, bacterial growth required for rapid, odorless decomposition of fish waste.

Compost materials can be amended. When primary compost is turned, dry manure or straw can be added to compost that is too wet, water can be added to compost that is too dry and improperly mixed materials can be remixed. A little experience and perseverance usually give good results in a short time.

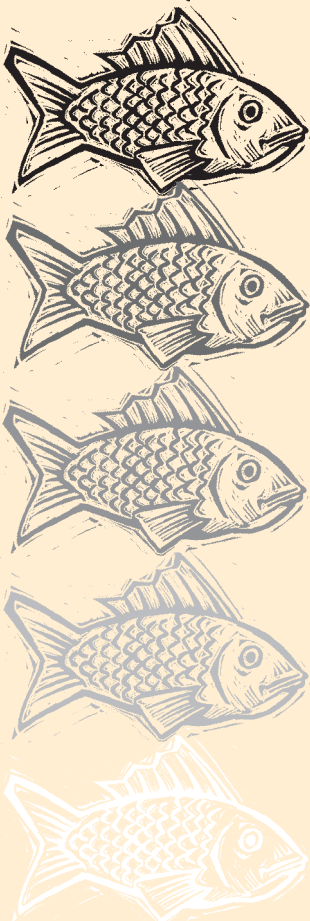

Composting -- A Disposal Method for Fish Waste

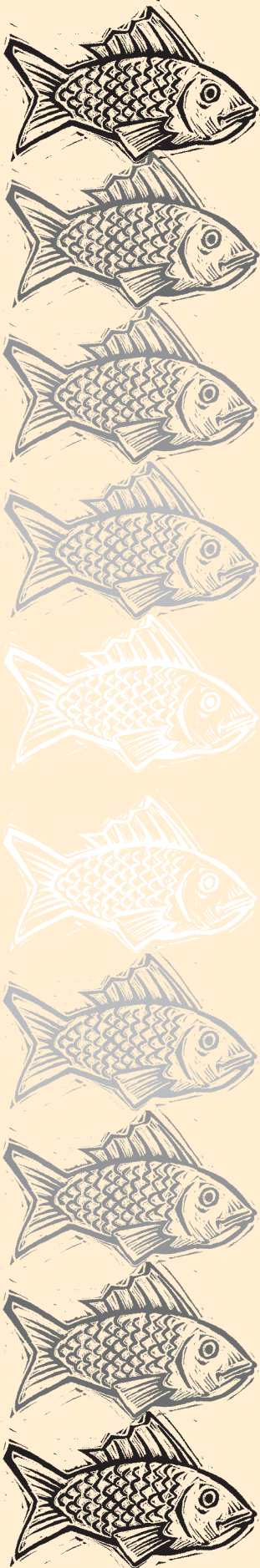

The following personnel from the LSU Agricultural Center contributed to this publication:

Dr. William Carney, Environmental Science Division

Dr. Thomas Lawson, Department of Biological and Agricultural Engineering (retired)

Dr. Gary Breitenbeck, Department of Agronomy

David Schellinger, Department of Agronomy

Funding for this publication includes Louisiana Department of Environmental Quality funds.

Visit our website: www.agctr.lsu.edu

Louisiana State University Agricultural Center

William B. Richardson, Chancellor

Louisiana Cooperative Extension Service

Jack L. Bagent, Vice Chancellor and Director

Pub. 2793

(10M) 2/2000

Issued in furtherance of Cooperative Extension work, Acts of Congress of May 8 and June 30, 1914, in cooperation with the United States Department of Agriculture. The Louisiana Cooperative Extension Service provides equal opportunities in programs and employment.